

NELUX ARCHITECTURAL LIGHTING PRODUCTS

LED LIGHT PROFILES 2025

WIP PRO

NELUX (HK) INTERNATIONAL,LTD

Head office: 18, harbour road, central plaza, 32/F, office 3208, wanchai, hong kong, china

website: www.nelux.com.hk

email: sales@nelux.com.hk

wechat: neluxury

tel: +852 28600042

fax: *852 28600066

About Us

Nelux: Professional Lighting Solutions

At Nelux, we have been lighting up ideas and projects around the world for over 30 years. Since establishing our headquarters in Hong Kong in 2010, we have become a trusted partner in the design and supply of technical and decorative lighting solutions for hotels, restaurants, franchises, retail stores, museums, and other commercial spaces.

Our philosophy blends innovation, design, and functionality to deliver high-performance products that not only meet but exceed the expectations of our clients. We focus on two key areas:

A premium range of interior lighting with a 5-year warranty, perfect for projects requiring durability and aesthetic excellence.

A bespoke production service that allows for the creation of unique pieces tailored to the specific needs of each client and project.

Our global market expertise, combined with an unwavering commitment to quality and competitive pricing, positions us as a leader in lighting solutions for large-scale projects. This catalog is a testament to our dedication and passion for illuminating every space with creativity and precision.



Optical

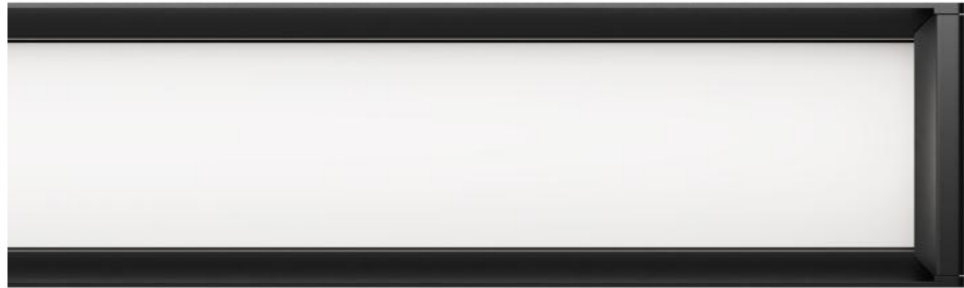

SMD linear lighting

Acrylic Diffuser cover



Prismatic linear lighting

Acrylic Prismatic cover



Honeycomb

Diffuser with honeycomb



COB linear spotlight

Anti-glare cup

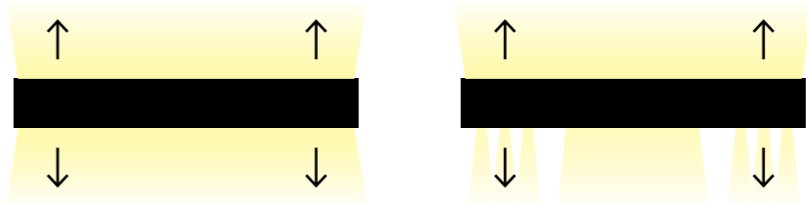

UP+DOWN:

UP and UP lighting

Control flexibility



On/Off
Control

DALIT8
Control

1-10V
dimmers

TRIAC
dimmers

DMX/RDM
Control

 DMXrdm



Common increase :

The multi-functional combination ensures that the light provides the final performance in many spaces; It can be matched with SMD, cellular network, cob, track and other accessory lighting systems, suitable for various lighting solutions.

A Track lighting can be added

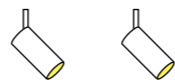

B Double sided lighting up and down



C SMD linear lighting

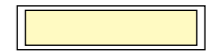

D Honeycomb

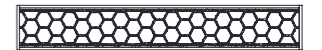

E COB linear spotlight--1/2

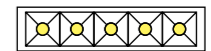

F COB linear spotlight)



G Rhombic filter linear spotlight



Intelligent induction



CCT setting

You can set the color temperature with a simple gesture. From 3000K warm tone to 6000K cold tone.

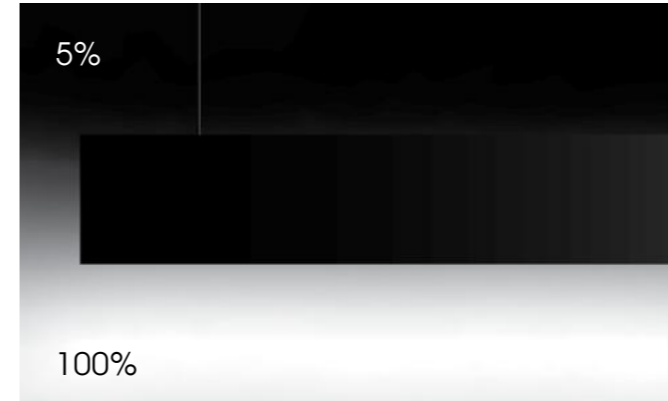
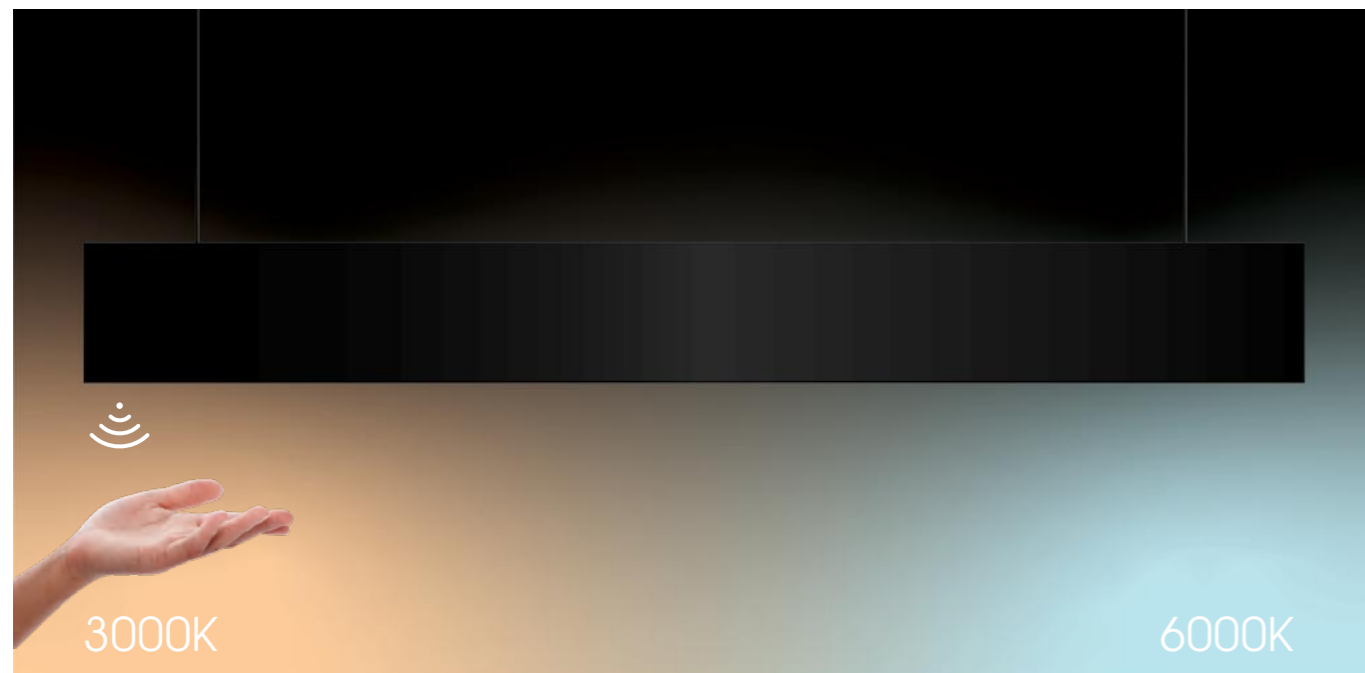

Dimmable 5%-100%

You can set the color temperature with a simple gesture. From 3000K warm tone to 6000K cold tone.



Light sensing dimmable

It provides double-sided light output through its two LED rings, and the upper and lower lights can operate independently of each other.



Icons

CE CE type certified products

 Color adjusting

CRI
>90 High color rendering index

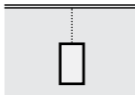
 Pendant direct

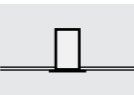
 Recessed trim-mounting

 Ceiling-mounted

 Indoor application

 brightness
Dimmable 5%~100%

IP20 Protection level

 Aluminum side pass

 Wall-mounting

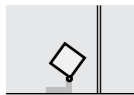
 Floor-mounted

 Anti glare

 Microwave induction

100V 100V~240V
240V Input voltage

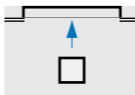
 Recessed immersible-mounting

 Floor-mounted

 Table-mounted

 High visual comfort

 Light sensing dimming

DIMM Dimming 0-10V

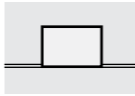
 Recessed trimless-mounting

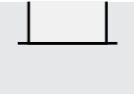
 Semi recessed-mounting

300mm
to
3000mm Size adjustable

 Gesture dimming

DALI DALI dimmable driver

3000k
24G
6000K Color temperature adjustable

 Hand scanning induction

 Delay light off

3000k
24G
4000K Color temperature adjustable

 Adjustable suspension wire

 Multiple splices

 Real sunshine experience

 Reduced Rayleigh scattering

 **3060**
Standard specifications

Directory index

Product series: WIP PLUS 维普 P • 吊装办公照明

Information

Technical features: CE, RoHS, Energy Star, DALI, CRI >90, IP20, 100V to 240V, 50/60Hz, 100000h

Product option: Colour: Sand black 砂黑, Sand white 砂白, Wood grain 木纹; Plug Colour: Matte black 哑黑, Matte white 哑白, Silver 银色

Product photo:

Light emitting mode:

Detailed Parameters:

Power	Flux	Size(LxWxH)	CC1	Beam Angle	Body Material	Diffuser Material	End Cap Material
25W/M	80-95LM/W	Lx75x95mm	3000K 4000K 6000K	180°	6063 Aluminum 6063 铝盖	PMMA 亚克力	Die casting aluminum 压铸铝

Drawing:

14

Living

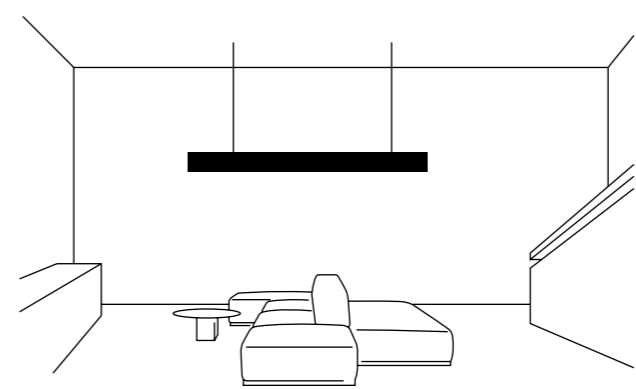

Sala reception

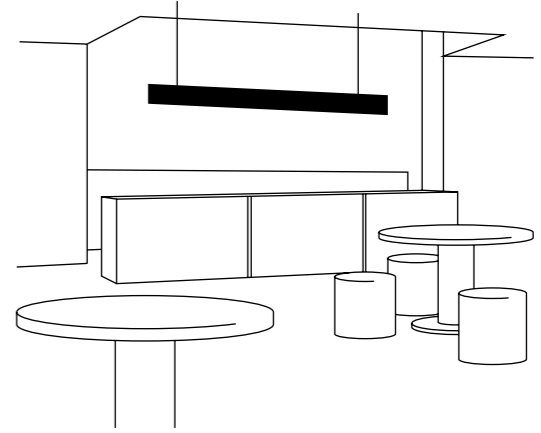

Accoglienza

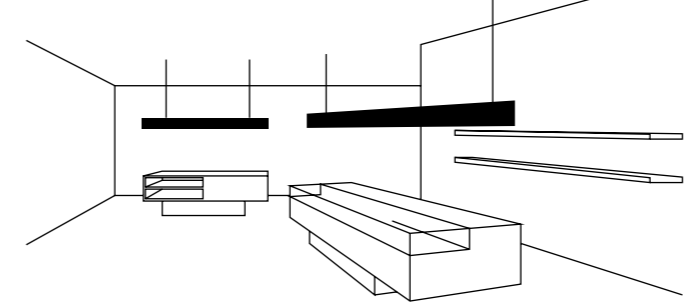

Office

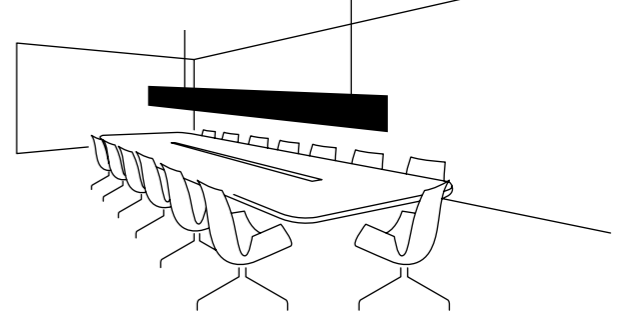

Fornire un'illuminazione efficiente e standard per lo spazio ufficio. Come lampadario, le lampade possono essere disposte in modo flessibile alla migliore altezza dell'ambiente ufficio. Raggiungere comfort visivo ed efficienza luminosa allo stesso livello elevato e portare il ritmo della luce solare in ufficio.

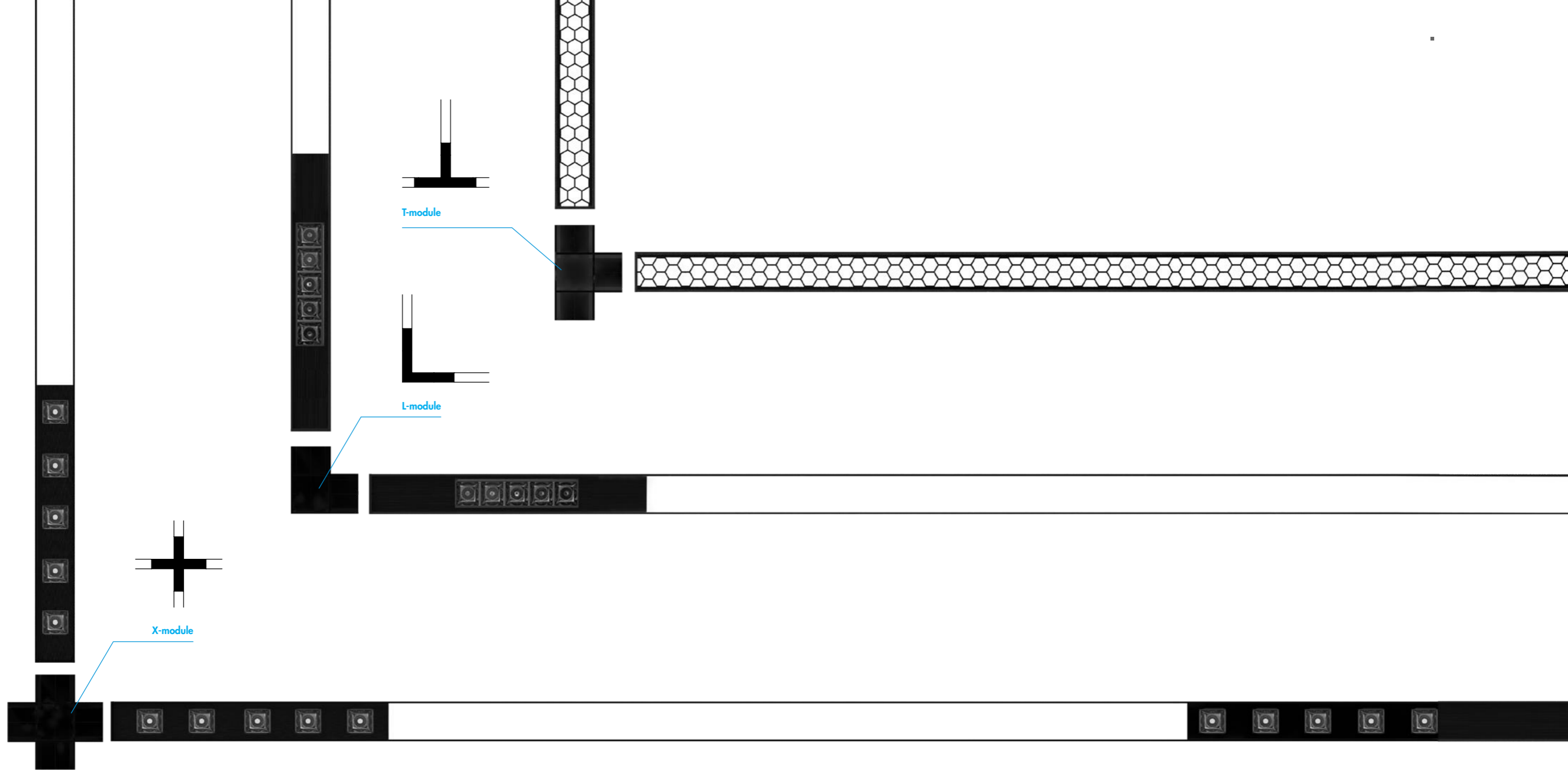

It adopts multi angle connectors, which is convenient and fast to install. There are five basic shapes that can be combined, and the shapes are changeable, which is more in line with the lighting requirements of modern office lighting.

Connection module :

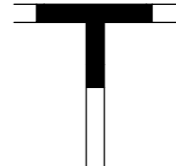
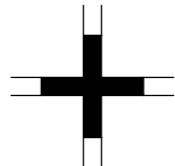
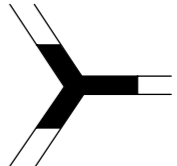
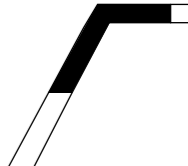
- | | | | | |
|-----------------------------------------------------------------------------------------------------------------------------------------------|-----------------------------------------------------------------------------------------------------------------------------------------------|-----------------------------------------------------------------------------------------------------------------------------------------------|-----------------------------------------------------------------------------------------------------------------------------------------------|----------------------------------------------------------------------------------------------------------------------------------------------------|
| <p>1 L-module
L -15W
305X43X66(2PCS)</p>  | <p>2 T-module
T -22W
255X43X66(3PCS)</p>  | <p>3 X-module
X -30W
255X43X66(4PCS)</p>  | <p>4 Y-module
Y -22W
288X43X66(3PCS)</p>  | <p>5 120°-module
120 -15W
313X43X66(2PCS)</p>  |
|-----------------------------------------------------------------------------------------------------------------------------------------------|-----------------------------------------------------------------------------------------------------------------------------------------------|-----------------------------------------------------------------------------------------------------------------------------------------------|-----------------------------------------------------------------------------------------------------------------------------------------------|----------------------------------------------------------------------------------------------------------------------------------------------------|

Product index

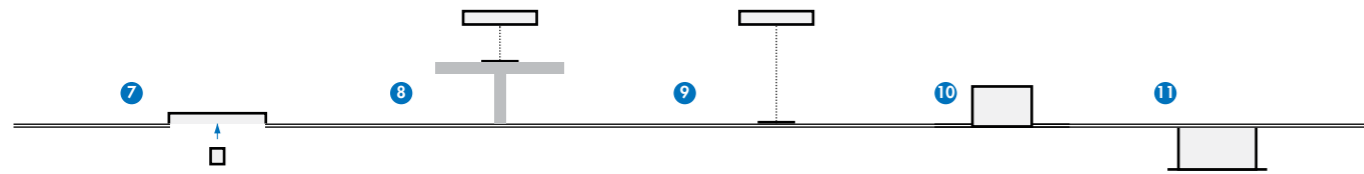

Page
P045~064

SUSPENSION

WIP PRO



KD921S-A P. 55



KD921S-F P. 55



KD921S-G P. 55



KD918-A P. 56

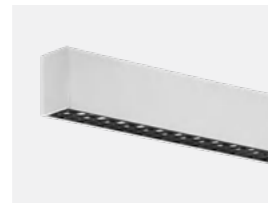

KD918-F P. 56



KD918/5T-G P. 56



KD918/1T-G P. 56

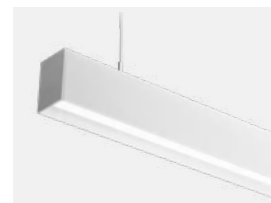

KD904-A P. 60



KD904-F P. 60



KD904/5T-G P. 60



KD904/1T-G P. 60



KD917S-A P. 62



KD917S-F P. 62



KD917/5T-G P. 62



KD917/1T-G P. 62



KD914-A P. 64



KD914-L P. 64



KD914/5T-G P. 64



KD914/1T-G P. 64



WIP PRO

Suspended



Six colors

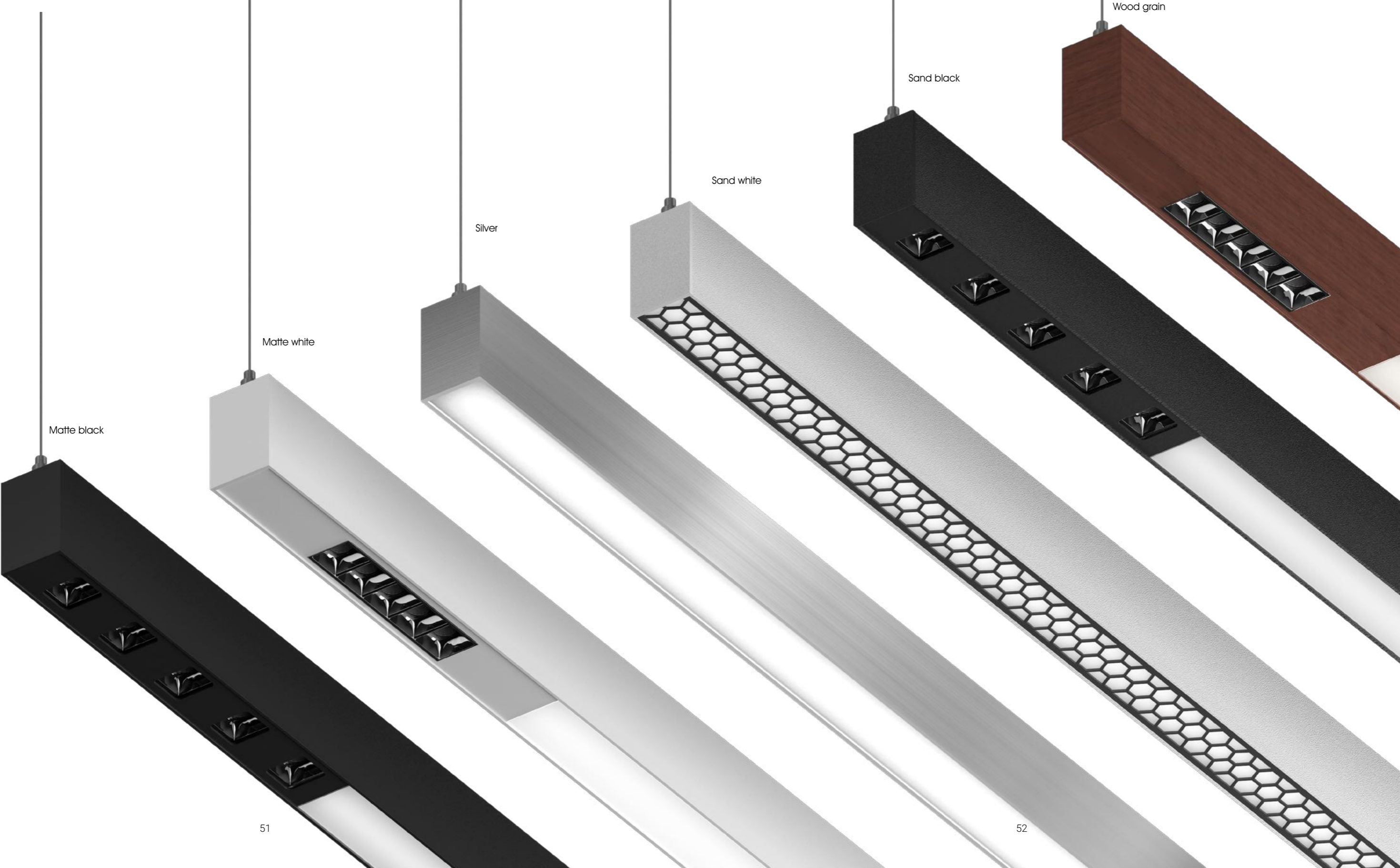

Matte black

Matte white

Silver

Sand white

Sand black

Wood grain



JNW lighting has the flexibility to adapt to every new situation and react to changing requirements in a room – whether you want to evenly light an entire wall or accentuate a particular object.

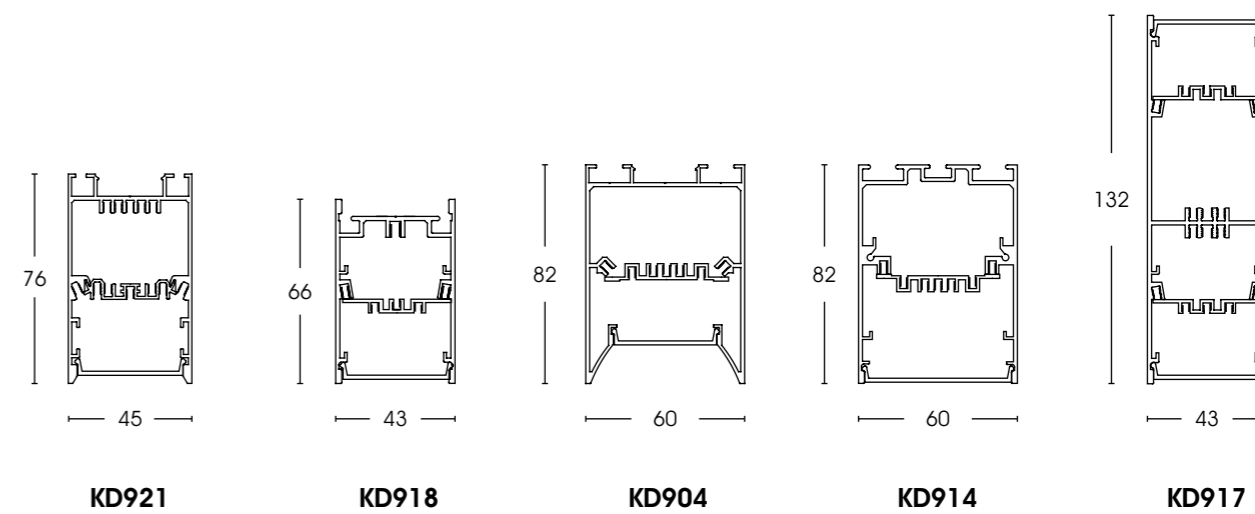

Information



Added: **A** + track light
B +up and down
C +SMD
D +honey comb
E1 +COB(5)+
E2 COB(3)
F +washer
G + prism

Colour: Sand black 砂黑 Sand white 砂白 Wood grain 木纹
 颜色 Matte black 哑黑 Matte white 哑白 Silver 银色

KD921S-A

Power	Flux	Size(LxWxH)	CCT	Beam Angle	Added	
25W/M	80-95 lm/W	Lx45x76mm	3000K 4000K 6000K	110°	A B C G	

KD921S-F

Power	Flux	Size(LxWxH)	CCT	Beam Angle	Added	
25W/M	80-95 lm/W	Lx45x76mm	3000K 4000K 6000K	110°	A B D	

KD921S-G

Power	Flux	Size(LxWxH)	CCT	Beam Angle	Added	
24W/24W+20W	2250 lm	1148x45x76mm	3000K 4000K 6000K	50°x50° 70°x70° 35°x70°	A B E1	

Information



Added: **A** + track light
B +up and down
C +SMD
D +honey comb
E1 +COB(5)+
E2 COB(3)
F +wall washer (5)
G + prism

Color: Sand black Sand white Wood
 Matte black Matte white grain Silver

KD918-A

Power	Flux	Size(LxWxH)	CCT	Beam Angle	Added	
25W/M	80-95 lm/W	Lx43x66mm	3000K 4000K 6000K	110°	A C G	

KD918-F

Power	Flux	Size(LxWxH)	CCT	Beam Angle	Added	
25W/M	80-95 lm/W	Lx43x66mm	3000K 4000K 6000K	110°	A D	

KD918/5T-G

Power	Flux	Size(LxWxH)	CCT	Beam Angle	Added	
35W	2625lm	1200x43x66mm	3000K 4000K	15° 30° 45°	A E1 D	

KD918/1T-G

Power	Flux	Size(LxWxH)	CCT	Beam Angle	Added	
35W	2625lm	1200x43x66mm	3000K 4000K	15° 30° 45°	A F D	





Information



Added: **A** + track **C** + SMD **E1** + COB(5) **F** + wall washer
B light **D** + honey **E2** + COB(3) **G** washer
+up and down comb +prism

Color: ● Sand black ● Sand white ● Wood grain
● Matte black ○ Matte white ● Silver

KD904-A ▲▲

Power	Flux	Size(LxWxH)	CCT	Beam Angle	Added	
上15W/M 下25W/M	80-95 lm/W	Lx60x82mm	3000K 4000K 6000K	60°	A B C G	

KD904-F ▲

Power	Flux	Size(LxWxH)	CCT	Beam Angle	Added	
25W/M	80-95 lm/W	Lx60x82mm	3000K 4000K 6000K	60°	A B D	

KD904/5T-G ▲

Power	Flux	Size(LxWxH)	CCT	Beam Angle	Added	
35W/35W+20W	2625lm	1200x60x82mm	3000K 4000K	15° 30° 45°	A B E1 D	

KD904/1T-G ▲

Power	Flux	Size(LxWxH)	CCT	Beam Angle	Added	
35W/35W+20W	2625lm	1200x60x82mm	3000K 4000K	15° 30° 45°	A B F D	



Information



Added: **A** + track light **B** +up and down **C** + SMD **D** + honey comb **E1** + COB(5) **E2** + COB(3) **F** + wall washer **G** +prism

Colour: Sand black, Sand white, Wood grain, Matte black, Matte white, Silver

KD917S-A

Power	Flux	Size(LxWxH)	CCT	Beam Angle	Added
up15W/M	80-95 lm/W	Lx43x132mm	3000K	110°	A C G
down 25W/M			4000K		
	6000K				

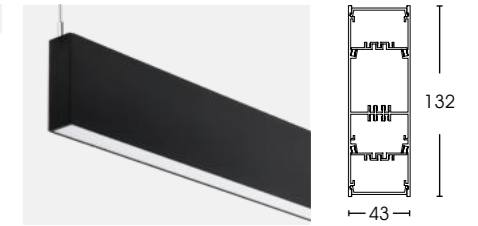

KD917S-F

Power	Flux	Size(LxWxH)	CCT	Beam Angle	Added
up 15W/M	80-95 lm/W	Lx43x132mm	3000K	110°	A C
down 25W/M			4000K		
	6000K				

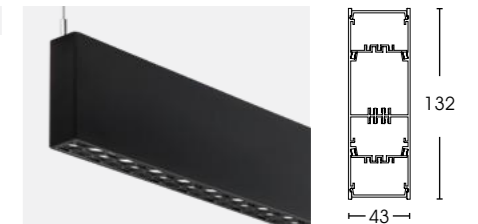

KD917/5T-G

Power	Flux	Size(LxWxH)	CCT	Beam Angle	Added
35W/35W+20W	4125 lm	1200x43x132mm	3000K	15° 30° 45°	A E1 D
			4000K		
40W/40W+20W	4500 lm	1200x43x132mm			

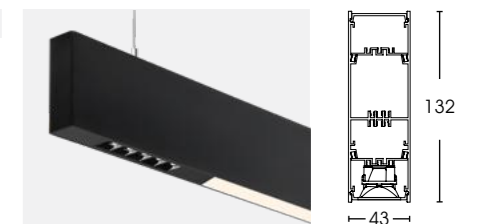

KD917/1T-G

Power	Flux	Size(LxWxH)	CCT	Beam Angle	Added
20W/20W+20W	4000 lm	1200x43x132mm	3000K	15° 30° 45°	A E1 D
			4000K		
35W/35W+20W	4125 lm	1200x43x132mm			

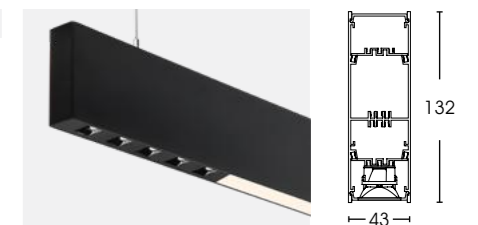

Information



Added: **A** + 轨道灯 **C** + SMD **E1** + COB(5个) **F** + 洗墙(5个)
 增加 **B** + 上下透光 **D** + 蜂窝网 **E2** + COB(3个) **G** + 棱晶

Colour: **●** Sand black 砂黑 **●** Sand white 砂白 **●** Wood grain 木纹
 颜色 **●** Matte black 哑黑 **○** Matte white 哑白 **●** Silver 银色

KD914-A ▲

Power	Flux	Size(LxWxH)	CCT	Beam Angle	Added
25W/M	80-95 lm/W	Lx60x82mm	3000K 4000K 6000K	110°	A C G

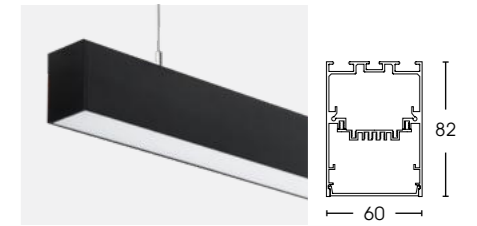

KD914-L ▲

Power	Flux	Size(LxWxH)	CCT	Beam Angle	Added
25W/M	80-95 lm/W	Lx60x82mm	3000K 4000K 6000K	120°	A C G

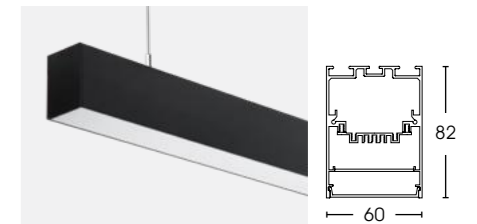

KD914/5T-G ▲

Power	Flux	Size(LxWxH)	CCT	Beam Angle	Added
45W	4275 lm	1200x60x82mm	3000K 4000K	15° 30° 45°	A E1

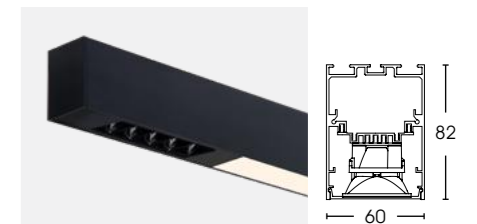

KD914/1T-G ▲

Power	Flux	Size(LxWxH)	CCT	Beam Angle	Added
33W	3135 lm	1200x60x82mm	3000K 4000K	15° 30° 45°	A E2

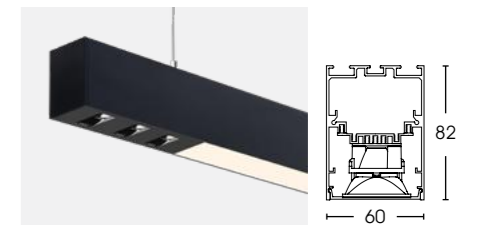

www.nelux.com.hk

sales@nelux.com.hk
salesnelux@gmail.com

neluxclients@gmail.com